



- Limitatore di momento
- Comandi bilaterali
- Sfilii esagonali
- Mart. sfilo indipendenti
- Mart. stab. fissi
- Stabilizzatori allargabili idraulicamente
- Valvole flangiatae
- Serbatoio olio
- Kit di montaggio
- Norma di progettazione: DIN 15018
- Classe di collaudo a fatica: B3
- Amco Veba Power System (A.V.P.S.)



- Load limiting device
- Dual controls
- Hexagonal section extension
- Independent extension cylinders
- Fixed stabilizer cylinders
- Outriggers with hydraulic extension
- Flanged valves
- Oil tank
- Assembly kit
- Design in accordance with DIN 15018
- Fatigue test classificatio: B3
- Amco Veba Power System (A.V.P.S.)



- Limiteur de moment
- Commandes bilaterales
- Extensions hexagonales
- Vérins d'extension indépendants
- Vérins stabilisateur fixes
- Stabilizateurs élargissables hydrauliquement
- Soupapes à bride
- Réservoir d'huile
- Kit de montage
- Normes de calcul: DIN 15018
- Tests de fatigue en classe: B3
- Amco Veba Power System (A.V.P.S.)



- Drehmomentbegrenzer
- Beidseitige Kransteuerung
- Sechskantige Auszüge
- Unabhängige Auszugzylinderbzylinder
- Fixed Zylinder
- Seitlich hydraulisch ausfahrbare
- Ventile mit Flansch
- Ölbehälter
- Montagesatz
- Berechnungsnorm nach DIN 15018
- Ermüdungstest in klasse: B3
- Amco Veba Power System (A.V.P.S.)



- Limitador de momento
- Mandos bilaterales
- Brazos telescópicos hexagonales
- Cilindros extensión independientes
- Gatos estabilizadores fijos
- Estabilizadores extraíbles hidráulicamente
- Valvulas pilotadas
- Deposito aceite
- Kit de ensablaje
- Norma del proyecto: DIN 15018
- Tipo de ensayo a la fatiga: B3
- Amco Veba Power System (A.V.P.S.)



- Limitador de momento
- Comandos bilaterales
- Extensoes hesagonais
- Cilindros de extensao independentes
- Gatos estabilizadores fijos
- Estabilizador alongadohidráulicamente
- Válvulas de segurança
- Deposito de óleo
- Kit de montagem
- Norma de proteccao DIN 15018
- Typo de Ensayo a la fatiga: B3
- Amco Veba Power System (A.V.P.S.)

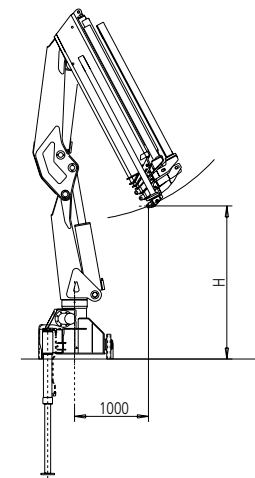
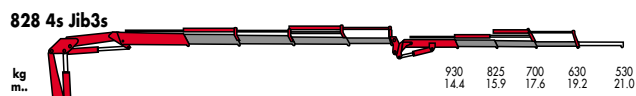
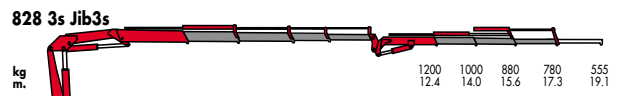
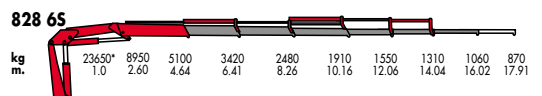
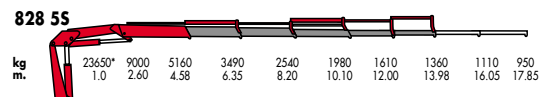
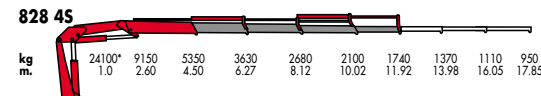
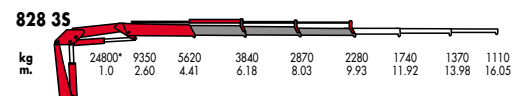
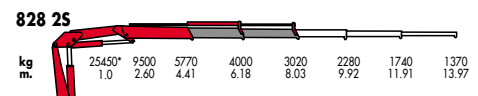
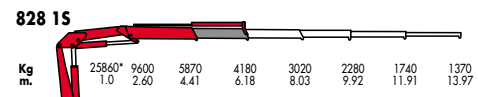

- H 828/2S = 2447**
- H 828/3S = 2401**
- H 828/4S = 2322**
- H 828/5S = 2219**
- H 828/6S = 2071**



(*) Portata teorica Theoretical lifting capacity

DATI TECNICI TECHNICAL DATA

MOD.	828/1S	828/2S	828/3S	828/4S	828/5S	828/6S	828/3S ₃	828/4S ₃
A	2500	2500	2500	2500	2500	2540	2500	2500
B	2320	2320	2320	2320	2320	2320	2430	2445
C	1507	1507	1507	1507	1507	1507	1507	1507
D	717	717	717	717	717	717	717	717
E	150	150	150	150	150	150	150	150
F	2300	2300	2300	2300	2300	2300	2300	2300
G	1600	1600	1600	1600	1600	1600	1600	1600
H	5500	5500	5500	5500	5500	5500	5500	5500
I	420	420	420	420	420	420	420	420
L	1115	1115	1115	1115	1115	1200	-	-
M	1280	1280	1280	1280	1280	-	1300	1300
	optional	optional	optional	optional	optional	-	std	std

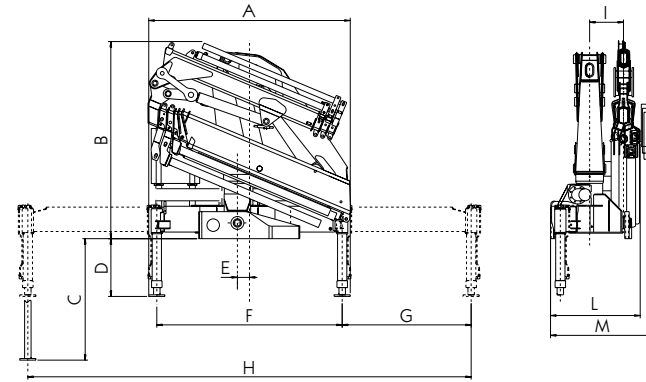

**MOMENTO DI SOLLEVAMENTO
MAX. LIFTING MOMENT
MOMENT D'ELEVATION MAX.
MAX. AUFHEBEMOMENT
MOMENTOS DE ELEVACION
MOMENTO DE ELEVACAO MAX.
(t.m.)**

828	1S	2S	3S	4S	5S	6S
base	25,9	25,5	24,8	24,1	23,7	23,7
Jib 3s		22,5	21,9			

**PENDENZA MAX. DI LAVORO
MAX WORKING HEEL
DEVERS MAXI DE TRAVAIL
MAX. ARBEITSNEIGUNG
INCLINACION MÁX. DE TRABAJO
PENDÊNCIA MÁX. DE TRABALHO
(°)**

828	
base	4°(8%)

**CAPACITÀ SERBATOIO OLIO
OIL TANK CAPACITY
CONTENANCE RÉSERVOIR HUILE
ÖLBEHALTERHINHALT
CAPACIDAD DEL DEPÓSITO ACEITE
CAPACIDADE DO DEPOSITO DE OLEO
(l.)**

828	
base	160

**SBRACCIO MAX. VERTICALE
MAX VERTICAL REACH
LONGEUR DU BRAS VERTICALE
MAX VERTIKAL REICHWEITE
ALCANGE MAX. VERTICAL
ALCANGE MAX. VERTICAL
(m.)**

828	1S	2S	3S	4S	5S	6S
base	9,83	11,6	13,3	15,2	17,1	19,0
man.	17,1	17,1	19,1	20,8	20,8	20,8
J.3s hyd.			20,8	22,1		
J.3s man.			21,9	23,9		

**PRESSIONE D'ESERCIZIO
WORKING PRESSURE
PRESSION DE SERVICE
BETRIEBSDRUCK
PRESIÓN DE TRABAJO
PRESSAO DE TRABALHO
(bar)**

828	
base	310

**PORTATA AL DISTRIBUTORE
OIL HYDRAULIC DISCHARGE TO THE DISTRIBUTOR BOX
DÉBIT D'UILE HYDRAULIQUE AU DISTRIBUTEUR
HYDRAULISCHE ÖL TRAGFÄHIGKEIT ZUM STEUERUNG
CAUDAL AL DISTRIBUIDOR
DESCARGA DE OLEO HIDRAULICO AO DISTRIBUIDOR
(l/min.)**

828	
base	50

**ANGOLO DI ROTAZIONE
SLEWING ANGLE
ANGLE ROTATION
DREHWINKEL
ANGULO DE ROTACION
ANGULO DE ROTACAO
(°)**

828	
base	400°

**PESO GRU SENZA STABILIZZATORI
CRANE WEIGHT WITHOUT STABILIZER
MASSE GRUE SANS STABILISATEURS
KRANGEWICHT OHNE STABILISATOREN
PESO DE LA GRUA SIN GATOS
PESO DA GRUA SEM ESTABILIZADORE
(kg.)**

828	1S	2S	3S	4S	5S	6S
base	2630	2810	2950	3110	3250	3345
Jib 3s			3500	3650		

**VELOCITÀ DI ROTAZIONE
SLEWING SPEED
VITESSE DE ROTATION
DREHGESCHWINDIGKEIT
VELOCIDAD DE ROTACION
VELOCIDADE DE RUTACAO
(400°)**

828	
base	50s

**PESO STABILIZZATORI
WEIGHT OF STABILIZERS
POIDS DES STABILISATEURS
GEWICHT DER STABILISATOREN
PESO GATOS EXTENSIBLES
PESO DOS ESTABILIZADORES
(kg.)**

828	
base	440

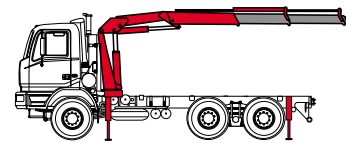

**Autocarro consigliato
Recommended truck
Camion conseillé
Camion aconsejado
Camiao aconselhado**
Passo - Pitch - Empattement - Passo: 4400 mm. M.T.T. ton 19 G.V.W. ton 19

ACCESSORI

- Prolunghe meccaniche
- Attivazione elementi supplementari*
- Posto di manovra in alto
- Verricello
- Comando a distanza
- *) no 828 - 6S

ACCESSORIES

- Manual extensions
- Supplementary element activation*
- Top seat
- Winch
- Remote control
- *) no 828 - 6S

ACCESSOIRES

- Rallonges mécaniques
- Activation éléments supplémentaires*
- Poste de manoeuvre en haut
- Treuil
- Commande à distance
- *) no 828 - 6S

ZUBEHOERE

- Mechanischer ausleger
- Steuerelemente einföhrung*
- Hoch föhlersitz
- Winsch
- Fernsteuerung
- *) no 828 - 6S

ACCESORIOS

- Prolongaciones mecánicas
- Activación elementos suplementarios*
- Puesto de maniobra arriba
- Cabrestante
- Mando a distancia
- *) no 828 - 6S

ACCESORIOS

- Prolongações mecánicas
- Activacao de elementos suplementares*
- Posto de manobra no cimo
- Guincho
- Comando a distancia
- *) no 828 - 6S

Dati, descrizioni e illustrazioni sono indicativi e non impegnano Amco Veba. Gru prodotte e/o commercializzate da Amco Veba - Data, descriptions and illustrations are merely indicative and not binding. Cranes manufactured and marketed by Amco Veba - Les données, descriptions et illustrations sont uniquement indicatives et n'engagent pas Amco Veba. Grues produites et/ou vendues par Amco Veba - Angaben, Beschreibungen und Abbildungen sind weisend und verpflichten Amco Veba. Die Kräne werden von Amco Veba hergestellt und/oder vermarktet - Los datos, las descripciones y las ilustraciones son indicativos y no implican compromiso para Amco Veba. Gruas producidas y/o comercializadas por Amco Veba - Os dados as descrições e ilustrações são indicativos e não comprometem Amco Veba. Guindaste produzidos e/ou comercializados pela Amco Veba.



828
A.V.P.S.

